

# Capacitive mTouch™ Sensing Solutions

## Design Guidelines

© 2008 Microchip Technology Incorporated. All Rights Reserved. Capacitive m Touch Sensing Solutions Slide 1

Hello, my name is Marc McComb, Technical Training Engineer in the Security Microcontroller and Technology Division here at Microchip. Thank you for viewing this webseminar detailing a few design guidelines for Microchip's Capacitive mTouch Sensing Solutions.



## Agenda

- **Overview/Review of Microchip's Capacitive mTouch™ Sensing Solution**
  
- **Design Guidelines for:**
  - Copper Pad Size
  - Adjacent Touch Sensors
  - Circuit Traces
  - Covering Plate
  - Other Considerations
  - Mounting

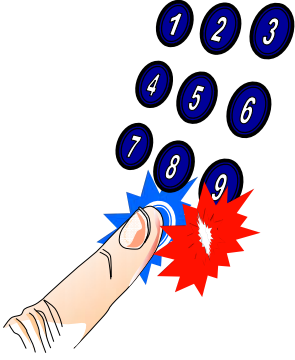

© 2008 Microchip Technology Incorporated. All Rights Reserved. Capacitive m Touch Sensing Solutions Slide 2

The discussion presented here assumes that you have viewed the previous webseminar Introduction to mTouch Capacitive Touch Sense. The main points from that webseminar will be briefly reviewed for clarity including the functional characteristics of a Capacitive mTouch Sensing Solution along with basic touch sensor construction. The primary focus here is to provide some basic design guidelines as they relate to touch sensor pad size, placement, cover plate material selection and mounting recommendations.



**Overview/Review of Capacitive  
mTouch™ Sensing Solution**

© 2008 Microchip Technology Incorporated. All Rights Reserved. Capacitive m Touch Sensing Solutions Slide 3

First, let's take a moment to review the basic components of Microchip's Capacitive mTouch Sensing Solution ...

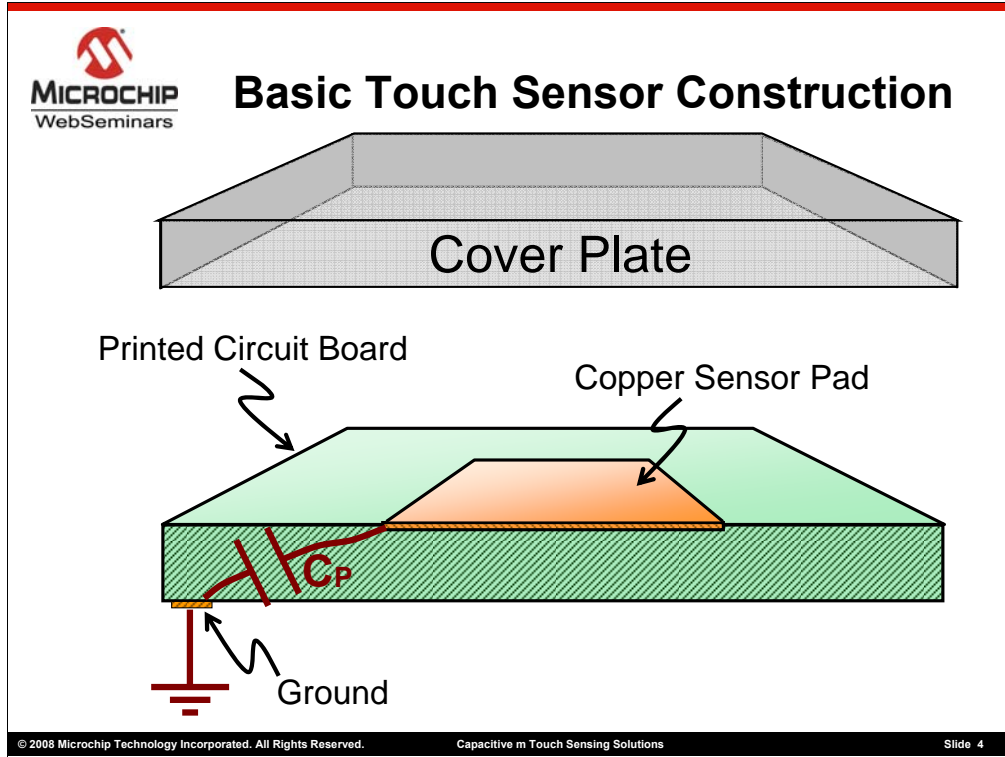

As discussed in the Introduction to mTouch Capacitive Touch Sense webseminar, a copper sensor pad is created on a printed circuit board that will create a capacitance in conjunction with grounds located elsewhere in the design. A covering plate is secured over the pad to create a touch surface.

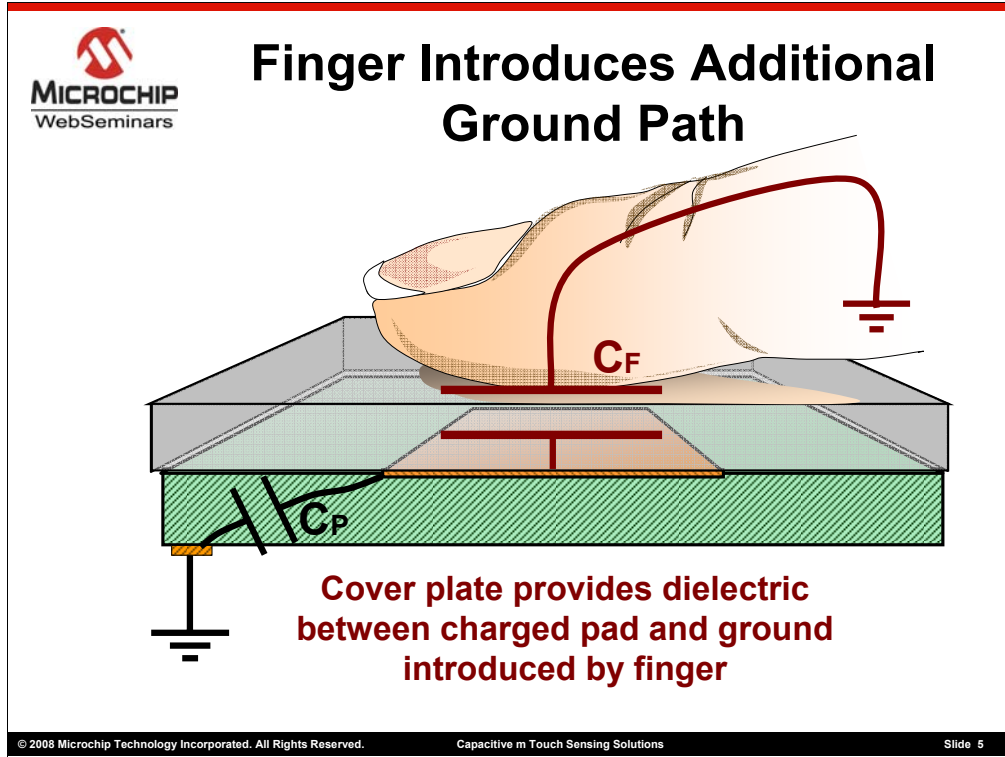

Touching the covering plate over a pad creates an additional parallel capacitance essentially coupled to ground. This adds to the overall capacitance generated by the touch sensor used to detect a finger press.

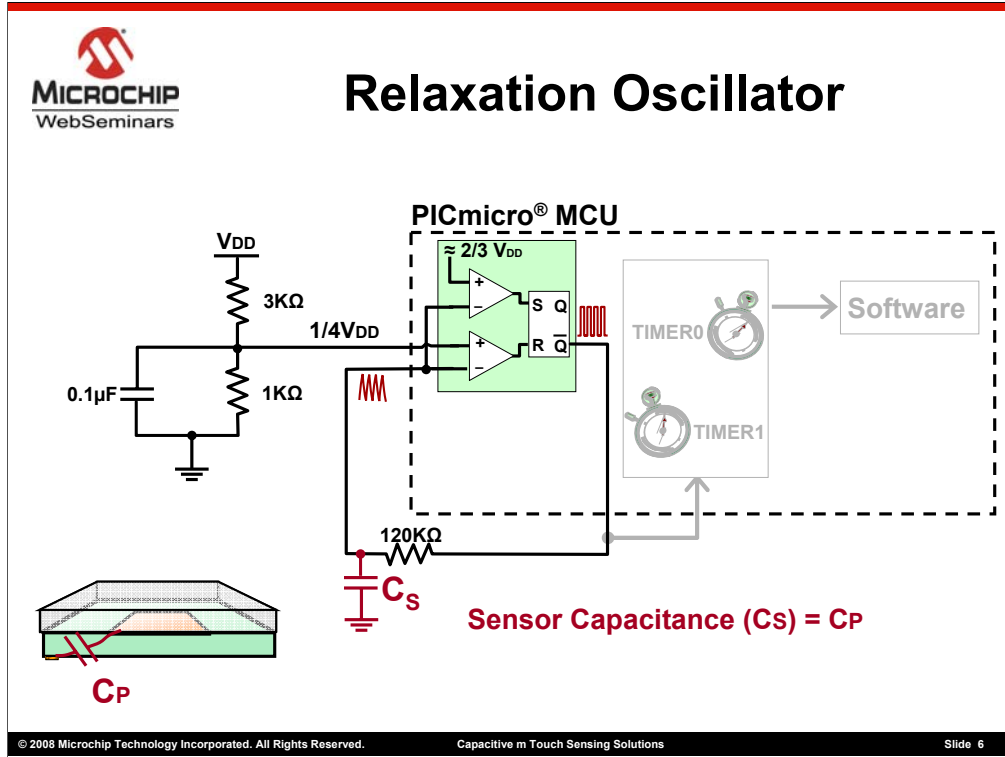

The capacitance generated by the touch sensor is used in conjunction with a dual comparator with SR latch peripheral found on newer PIC MCUs along with external components to generate a relaxation oscillator. The operation of this oscillator is discussed in great detail in the Introduction to mTouch Capacitive Touch Sensing webseminar and should be referenced for more information. Suffice to say that this configuration will generate an oscillation on the Q bar output of the SR latch. The frequency of oscillation will be determined by the capacitance generated by the touch sensor represented here by Cs. Alone, the touch sensor generates a particular frequency of oscillation.

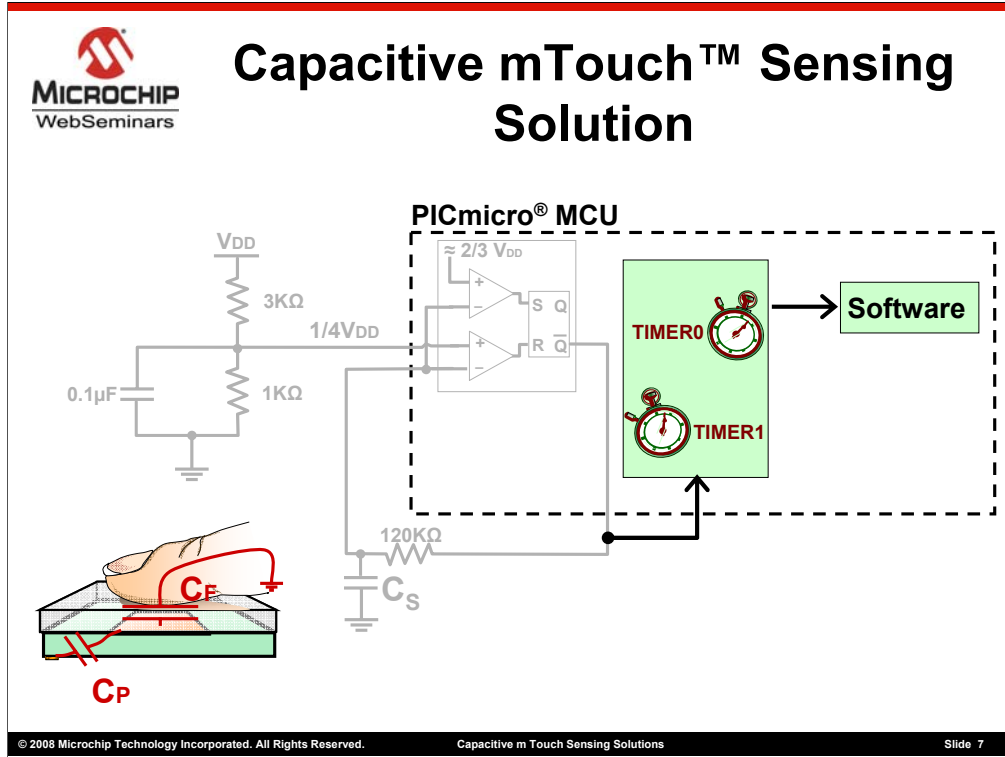

The frequency of the oscillator is then measured in fixed intervals using both Timer0 and Timer1 peripherals. Any shift due to a user's touch is detected and validated in software.



# Design Guidelines

© 2008 Microchip Technology Incorporated. All Rights Reserved. Capacitive m Touch Sensing Solutions Slide 8

However, this isn't the end of the story. Some design guidelines will need to be considered when developing any Capacitive mTouch Sensing application.

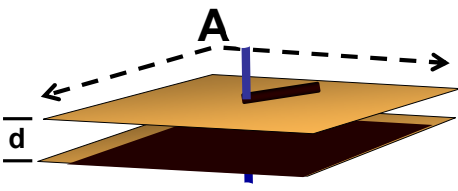

 **Capacitance Equation**

$$C = \frac{\epsilon_0 \epsilon_r A}{d}$$

**$\epsilon_0$**  Permittivity of Free Space (8.854 Pico-Farad/meter)  
 **$\epsilon_r$**  Relative Dielectric Constant (unit-less)  
**A** Area of Plates (meters)  
**C** Capacitance (Farads)  
**d** Distance between plates (meters)

© 2008 Microchip Technology Incorporated. All Rights Reserved. Capacitive m Touch Sensing Solutions Slide 9

The basic capacitance equation we have looked at in previous webseminars will be used as a reference for most of the design guidelines introduced here. Looking closely at the variables that make up this equation, you may notice that each could be easily altered depending on the implementation of this technology in your design.



# Touch Sensor Size

© 2008 Microchip Technology Incorporated. All Rights Reserved. Capacitive m Touch Sensing Solutions Slide 10

For example, the size of our touch sensor pad will have a huge impact on the capacitance generated by the sensor.

 **Pad Shape and Size**

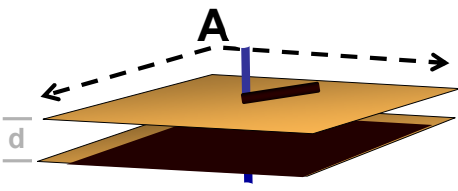
$$C = \frac{\epsilon_0 \epsilon_r A}{d}$$

**↑ Area → ↑ Capacitance**

© 2008 Microchip Technology Incorporated. All Rights Reserved. Capacitive m Touch Sensing Solutions Slide 11

The greater the Area, the greater the capacitance. Therefore, Increasing the area proportionally increases the capacitance allowing better detection and sensitivity. Notice that this equation doesn't take into consideration the shape of the pad. This means that some latitude can be taken when going for a more aesthetically appealing pad design.

 **Pad Shape and Size**

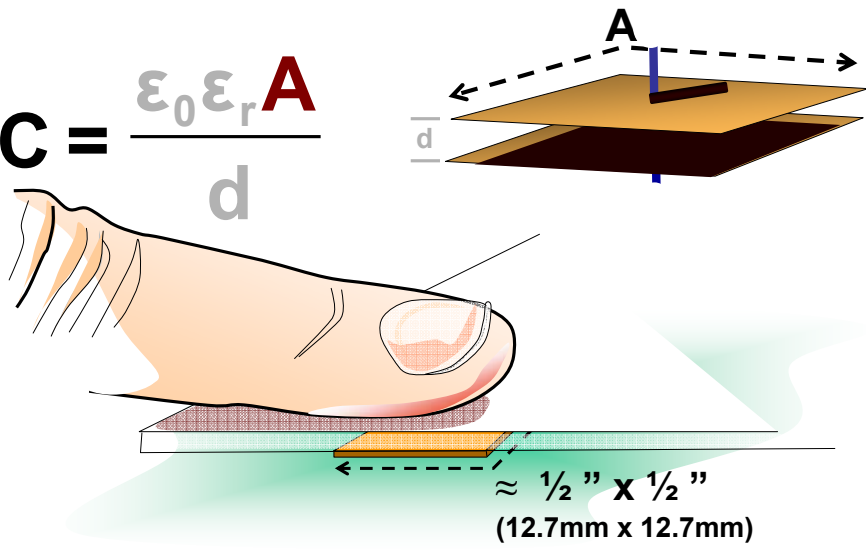
$$C = \frac{\epsilon_0 \epsilon_r A}{d}$$

$\approx \frac{1}{2}'' \times \frac{1}{2}''$   
(12.7mm x 12.7mm)

© 2008 Microchip Technology Incorporated. All Rights Reserved. Capacitive m Touch Sensing Solutions Slide 12

So how big should your pad be? As a very general rule of thumb, the area of the pad should be about the size of the average finger tip approximately  $\frac{1}{2}'' \times \frac{1}{2}''$ .



# Adjacent Touch Sensors

© 2008 Microchip Technology Incorporated. All Rights Reserved. Capacitive m Touch Sensing Solutions Slide 13

Typically, we will be implementing more than one touch button in an application. Therefore, another factor to consider is the proximity of adjacent touch pad sensors to each other.

 **Adjacent Touch Sensors**

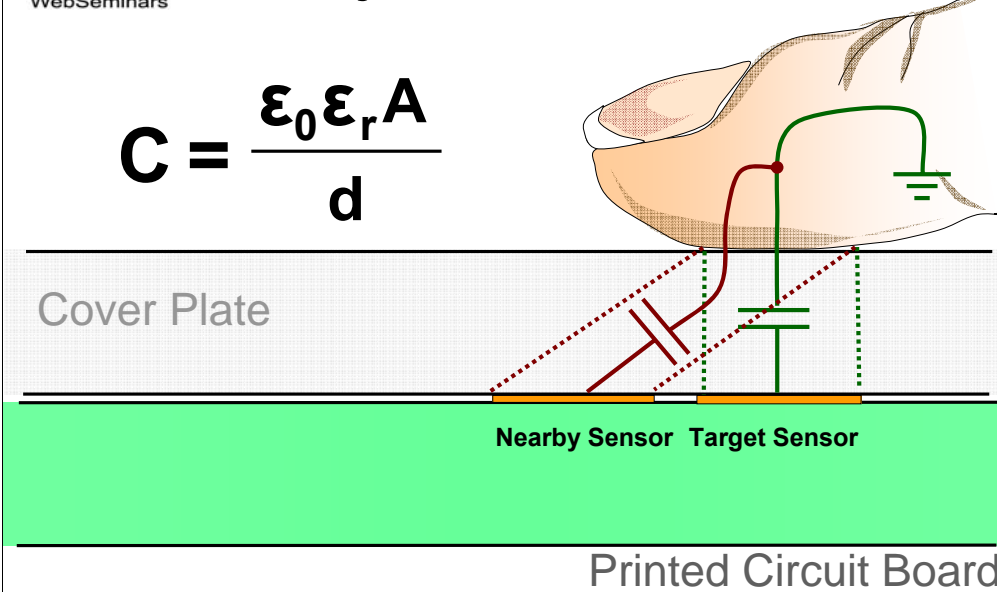
$$C = \frac{\epsilon_0 \epsilon_r A}{d}$$

The diagram illustrates an exaggerated side view of two touch sensor pads on a Printed Circuit Board (PCB) covered by a Cover Plate. A hand is shown touching the cover plate. The PCB has two sensor pads: a 'Nearby Sensor' (red) and a 'Target Sensor' (green). A finger is shown touching the target sensor, but the diagram highlights that the finger's proximity to the nearby sensor can create a parasitic capacitance, potentially triggering a false press. The PCB is shown with a green layer and a white layer. The cover plate is a grey textured layer. The PCB is labeled 'Printed Circuit Board' at the bottom. The cover plate is labeled 'Cover Plate' on the left. The sensors are labeled 'Nearby Sensor' and 'Target Sensor' at the bottom. The diagram also shows a battery symbol connected to the target sensor and a red wire connected to the nearby sensor.

© 2008 Microchip Technology Incorporated. All Rights Reserved. Capacitive m Touch Sensing Solutions Slide 14

Here an exaggerate side view of two touch sensor pads are shown along with the printed circuit board and covering plate. Once a finger press is introduced, a capacitance large enough to trigger a false press on a nearby sensor could be generated if positioned too close to the target sensor.

 **Adjacent Touch Sensors**

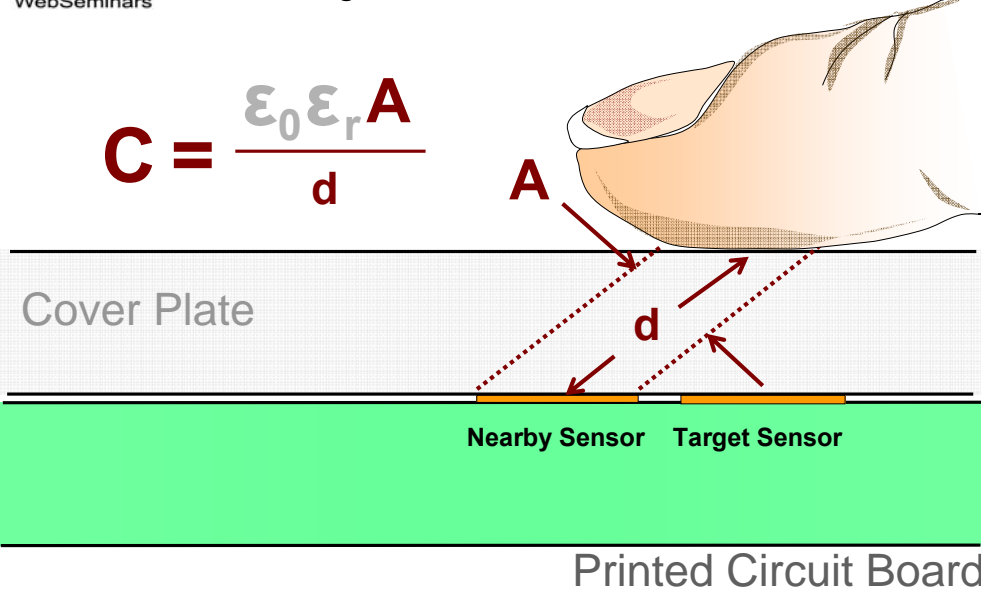
$$C = \frac{\epsilon_0 \epsilon_r A}{d}$$

Cover Plate

Nearby Sensor Target Sensor

Printed Circuit Board

© 2008 Microchip Technology Incorporated. All Rights Reserved. Capacitive m Touch Sensing Solutions Slide 15

In this situation, two of the variables from the capacitance equation are considered. Area in the numerator and distance in the denominator as they relate to the finger press.

**MICROCHIP**  
WebSeminars

## Adjacent Touch Sensors

$$C = \frac{\epsilon_0 \epsilon_r A}{d}$$

Cover Plate

Nearby Sensor Target Sensor

Printed Circuit Board

© 2008 Microchip Technology Incorporated. All Rights Reserved. Capacitive m Touch Sensing Solutions Slide 16

Moving the nearby sensor away from the target sensor will increase the distance value in the capacitance equation in relation to the finger press. Also note that the Area variable will also decrease due to simple geometry contributing to a further decrease in capacitance.

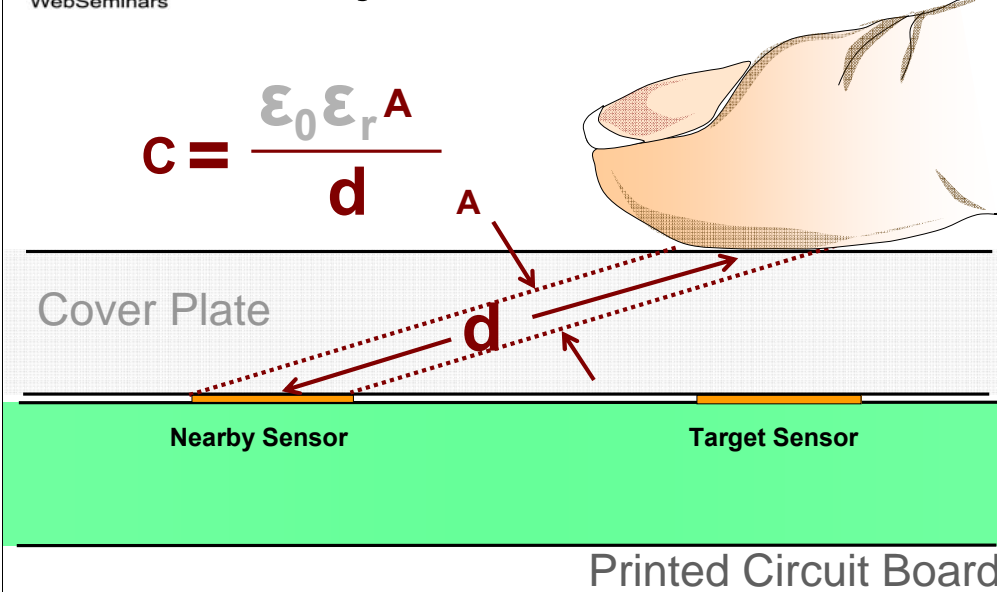

 **Adjacent Touch Sensors**

$$C = \frac{\epsilon_0 \epsilon_r A}{d}$$

The diagram illustrates the physical structure of adjacent touch sensors. It shows a hand touching a **Cover Plate** which is mounted on a **Printed Circuit Board**. Two sensors are shown on the PCB: a **Nearby Sensor** and a **Target Sensor**. The distance between the sensors is labeled **d**. The area of the sensor is labeled **A**. The capacitance equation  $C = \frac{\epsilon_0 \epsilon_r A}{d}$  is shown above the diagram.

© 2008 Microchip Technology Incorporated. All Rights Reserved. Capacitive m Touch Sensing Solutions Slide 17

The diagram illustrates the relationship between a finger, a cover plate, and two adjacent sensors on a PCB. A hand is shown touching a grey cover plate. Below the cover plate, two sensors are shown on a green PCB: a 'Nearby Sensor' and a 'Target Sensor'. The distance between the centers of these two sensors is labeled as  $d$ . The area of the finger in contact with the cover plate is labeled as  $A$ . The capacitance equation  $C = \frac{\epsilon_0 \epsilon_r A}{d}$  is shown above the diagram. A bracket below the sensors indicates a spacing of  $\frac{1}{4}'' (4.7 \text{ mm})$ . The PCB is labeled 'Printed Circuit Board'.

**MICROCHIP**  
WebSeminars

## Adjacent Touch Sensors

$$C = \frac{\epsilon_0 \epsilon_r A}{d}$$

Cover Plate

Nearby Sensor  $\frac{1}{4}'' (4.7 \text{ mm})$  Target Sensor

Printed Circuit Board

© 2008 Microchip Technology Incorporated. All Rights Reserved. Capacitive m Touch Sensing Solutions Slide 18

Therefore, to minimize the sensitivity of nearby sensors to a finger press, adjacent sensors should be spaced appropriately. Maintaining a distance of around  $\frac{1}{4}''$  between adjacent sensors should provide sufficient insulation from the finger.

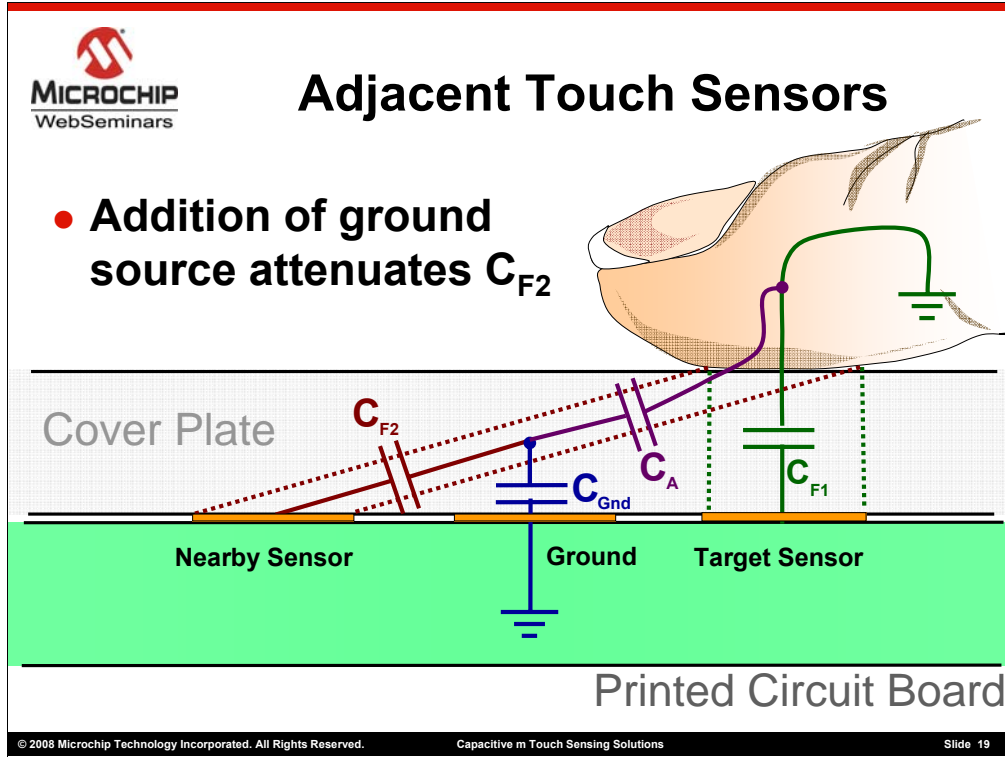

An alternate method of decreasing nearby sensor sensitivity is the introduction of a ground trace between adjacent sensors. With the ground trace so close to each touch sensor pad, a larger base capacitance is generated. The capacitance generated with the introduction of a finger press will therefore have less of an effect on the percent shift of the oscillator frequency.

 **Adjacent Touch Sensors**

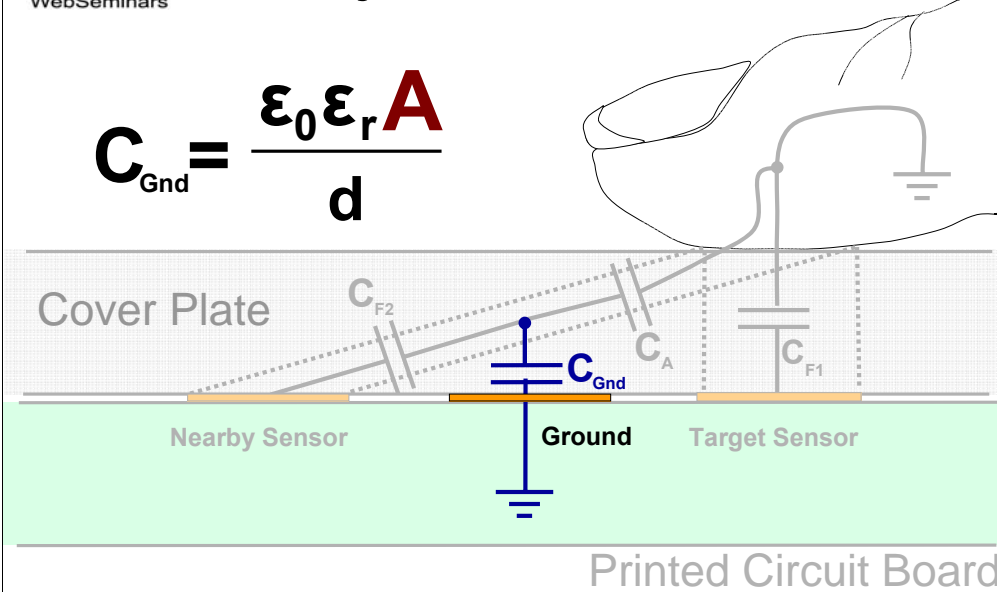
$$C_{Gnd} = \frac{\epsilon_0 \epsilon_r A}{d}$$

The diagram illustrates the cross-section of adjacent touch sensors. It shows a **Cover Plate** at the top, a **Printed Circuit Board** at the bottom, and a **Ground** layer in between. Two sensors are shown: a **Nearby Sensor** and a **Target Sensor**. The ground trace is wider under the nearby sensor, which is labeled  $C_{Gnd}$ . Other capacitance labels include  $C_{F2}$  (fringe capacitance between the nearby sensor and ground),  $C_A$  (area capacitance between the nearby sensor and ground),  $C_{F1}$  (fringe capacitance between the target sensor and ground), and  $C_{F1}$  (fringe capacitance between the target sensor and ground).

© 2008 Microchip Technology Incorporated. All Rights Reserved. Capacitive m Touch Sensing Solutions Slide 20

This attenuation can be manipulated by altering the area of the ground trace. The greater the Area of the ground trace, the greater the attenuation.

 **Adjacent Sensors**

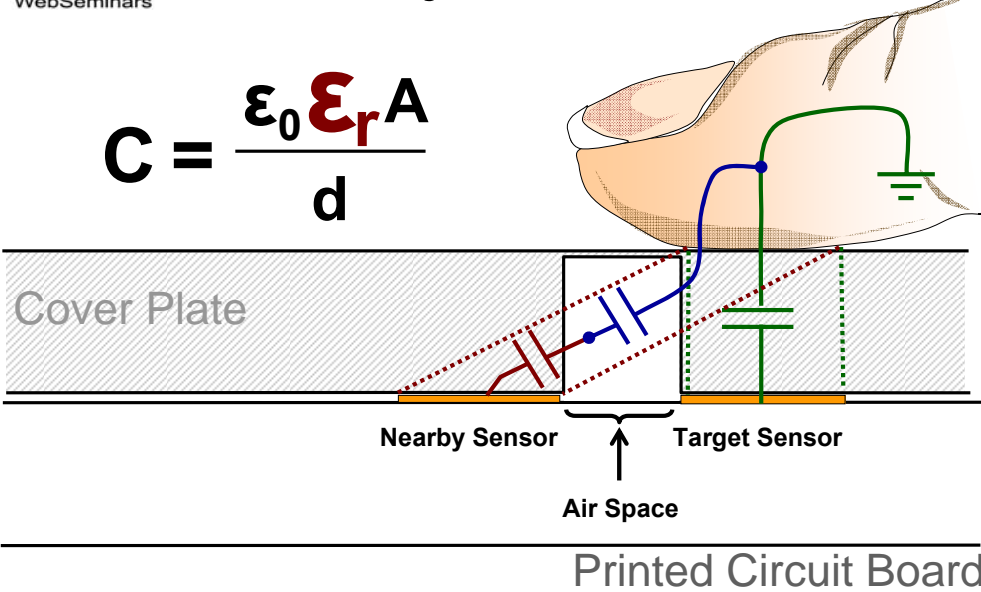
$$C = \frac{\epsilon_0 \epsilon_r A}{d}$$

Cover Plate

Nearby Sensor

Target Sensor

Air Space

Printed Circuit Board

© 2008 Microchip Technology Incorporated. All Rights Reserved. Capacitive m Touch Sensing Solutions Slide 21

Another solution is to create a relief in the covering material between adjacent sensors, introducing air into the space. Since air has a very low dielectric constant ( $\epsilon_r$ ) close to 1, a very low capacitance is created within the gap in-series with the capacitance on the nearby sensor. The total of both capacitances therefore approaches the smaller air gap capacitance minimizing the chance of a false trigger on the nearby sensor.



# Circuit Trace Design Considerations

© 2008 Microchip Technology Incorporated. All Rights Reserved. Capacitive m Touch Sensing Solutions Slide 22

Once the sensor pad design has been optimized we now need to consider the traces that connect them to the PIC Microcontroller.

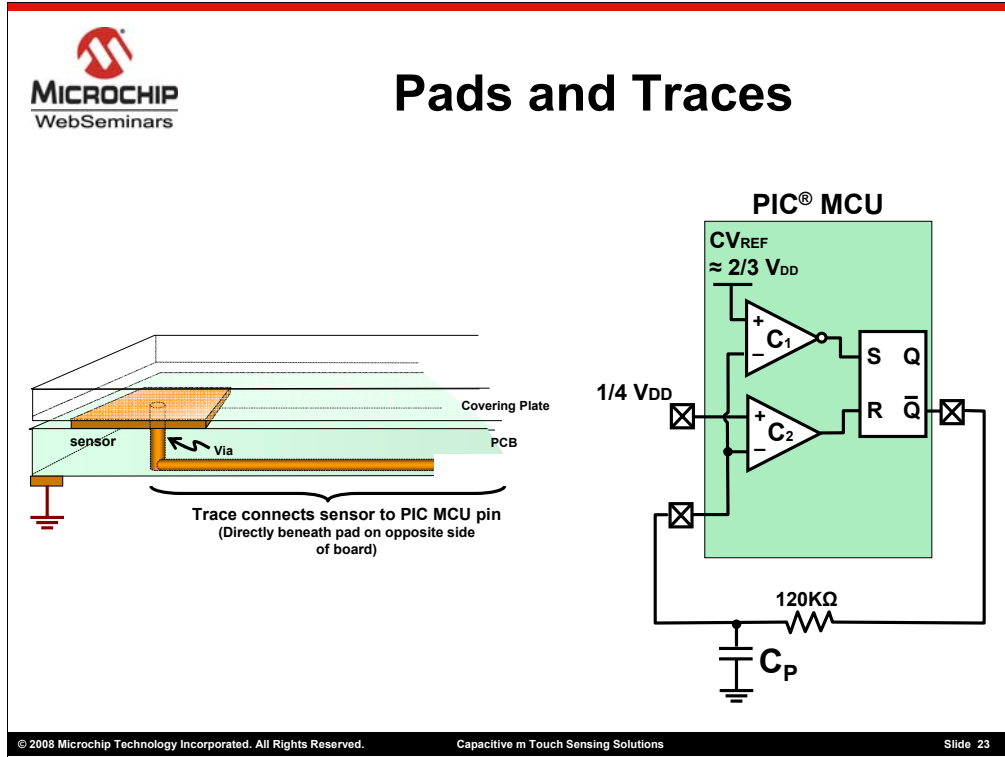

Shown in this slide is a touch sensor pad on the top side of the PCB. Directly beneath the pad is a via connecting to a copper trace.

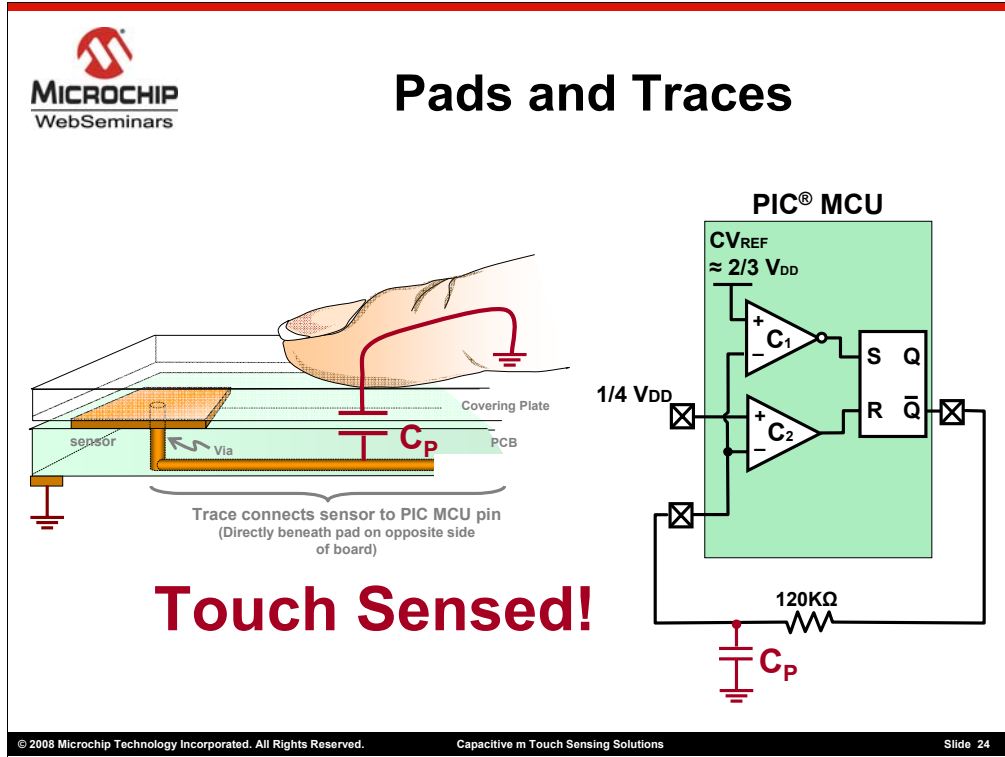

There is a chance that a system could be sensitive enough that a finger press directly above a trace could trigger a button press detection on the associated sensor. There are a couple of solutions for this. The first is dealt with in software by experimenting with sensor thresholds in the button press detection algorithm. However, some caution must be used when using this method as setting thresholds too aggressively could reduce reliability for different users. Note that each user will produce a different capacitive shift.





## Pads and Traces

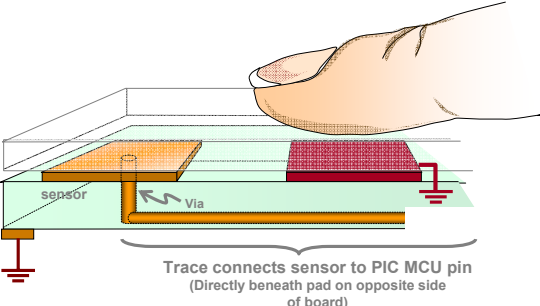

**Solves problem but increases base capacitance**

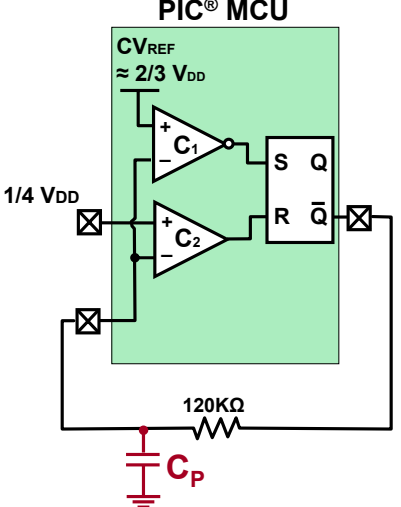

© 2008 Microchip Technology Incorporated. All Rights Reserved. Capacitive m Touch Sensing Solutions Slide 25

The second method introduces a ground pad placed directly opposite the trace. This solution works but remember a decrease in the distance between ground and sensor will increase the sensor's base capacitance. Therefore, it is suggested that traces be routed away from areas that have the potential of coming into contact with finger presses.

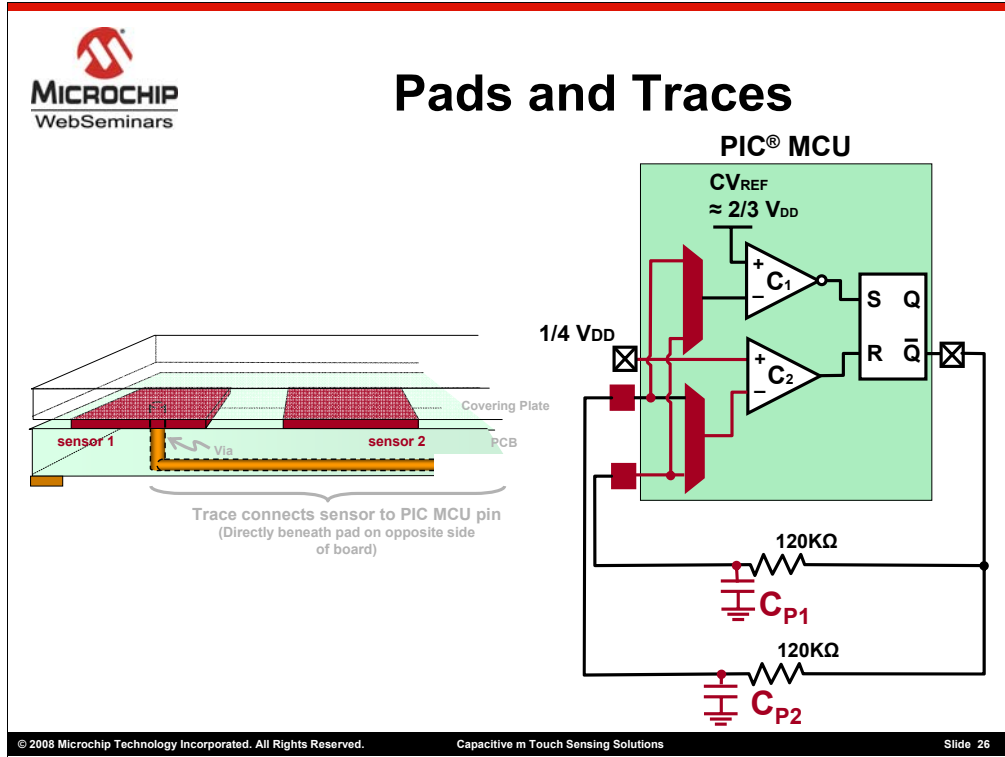

Another consideration with trace placement is in relation to other sensors on the board. In this slide two adjacent touch pad sensors are positioned so that the trace from sensor 1 passes directly below sensor 2.

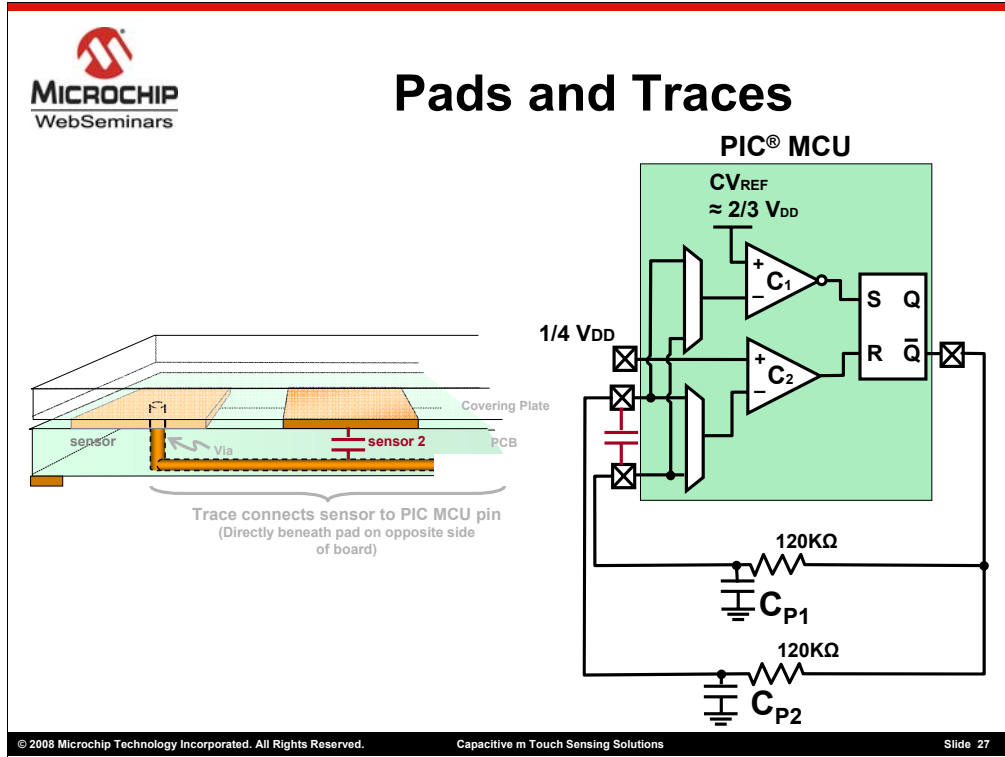

This configuration could produce the condition shown wherein a parasitic capacitance is generated between both sensor pads.

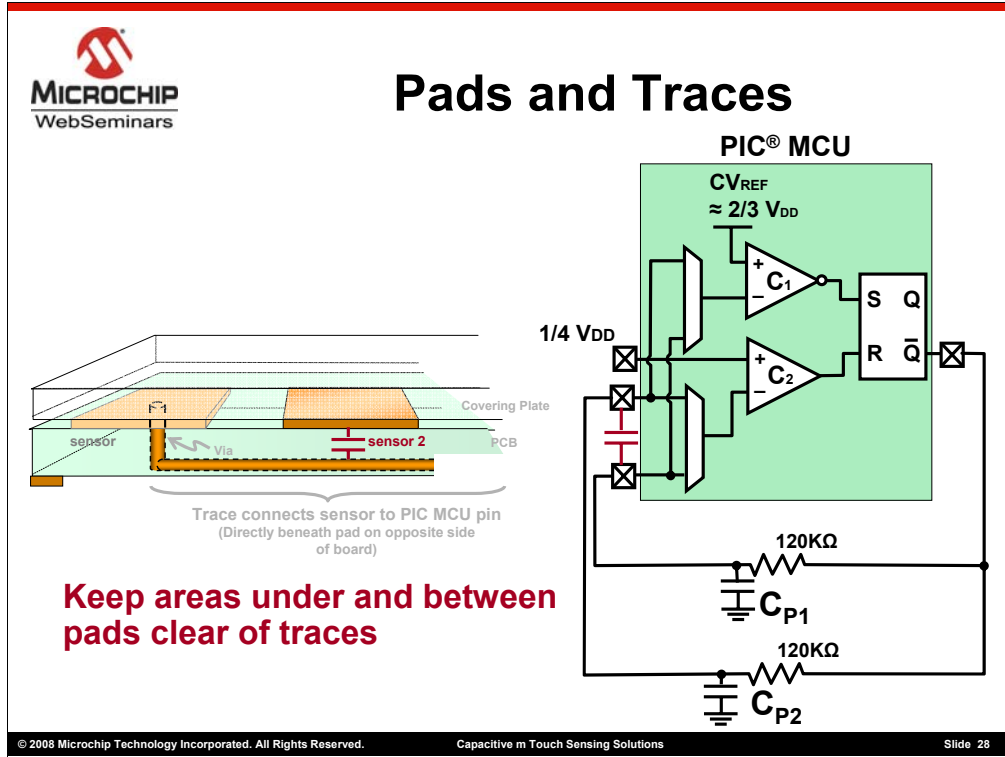

A good rule of thumb when laying out your design is to ensure that areas underneath touch sensor pads are kept clear of traces altogether.

 **Other Trace Considerations**

- **Traces connected to pad**
  - keep small
  - properly space traces
    - from each other and ground

↓ **Parasitic capacitance & Coupling of sensors**

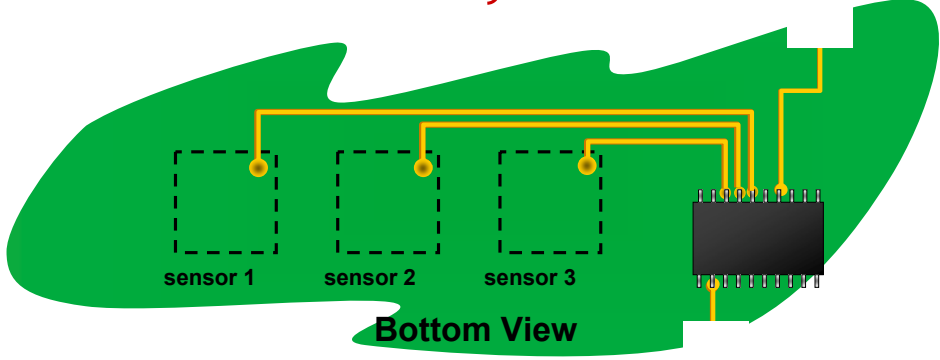

**Bottom View**

© 2008 Microchip Technology Incorporated. All Rights Reserved. Capacitive m Touch Sensing Solutions Slide 29

Some other things to consider as they pertain to circuit traces. Whenever possible, traces should be kept as small as possible and positioned away from ground sources and other traces. This will minimize the occurrence of unwanted parasitic capacitance or inadvertently coupling sensors together.



The slide features the Microchip logo and 'WebSeminars' text in the top left corner. The main title 'Covering Plate' is centered in a large, bold, black font. At the bottom, a black footer bar contains the text '© 2008 Microchip Technology Incorporated. All Rights Reserved.', 'Capacitive m Touch Sensing Solutions', and 'Slide 30'.

We have covered some basic design guidelines for touch pad sensors. Let's now look at the covering plate that will provide the touch surface in our application.

 **COVERING PLATE THICKNESS**

- **Thinner covering plates increase sensitivity and accuracy**

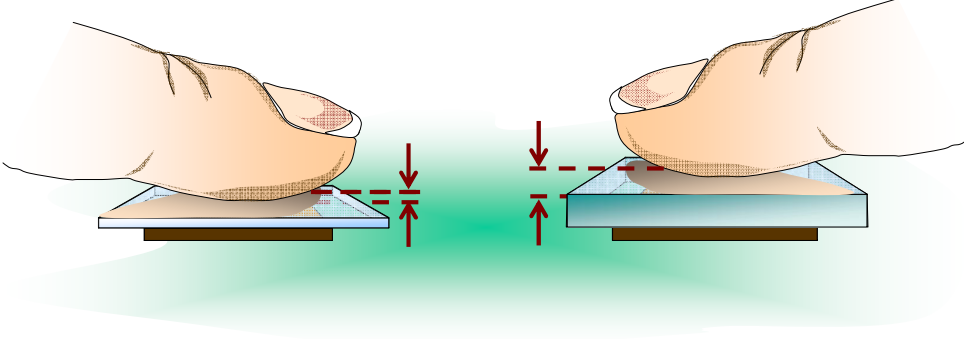

© 2008 Microchip Technology Incorporated. All Rights Reserved. Capacitive m Touch Sensing Solutions Slide 31

Sensor sensitivity will vary with thickness and composition of the material used. In capacitive sensing applications it has been found that extremely thin plate thicknesses make for a more accurate and sensitive sensor.

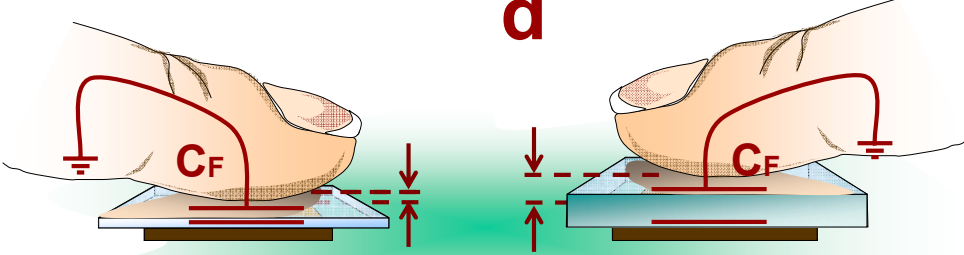

## Covering Plate Thickness

$$C = \frac{\epsilon_0 \epsilon_r A}{d}$$

© 2008 Microchip Technology Incorporated. All Rights Reserved. Capacitive m Touch Sensing Solutions Slide 32

Referring back to the capacitance equation we can clearly see one reason why. As the denominator representing the distance between our two plates (i.e. the pad and associated ground) increases the capacitance will become smaller. The Capacitive mTouch™ Sensing system has been tested and found to work well with Window glass and Plexiglas thicknesses of 2mm to 5mm. Other materials could be used however attention must be paid to the dielectric constant of the material.

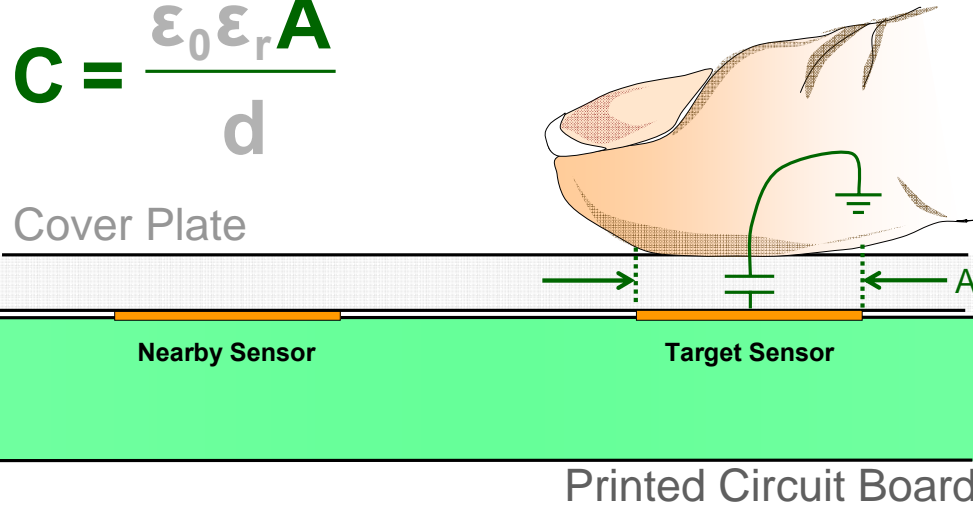

 **Thinner Covering Plates**

$$C = \frac{\epsilon_0 \epsilon_r A}{d}$$

Cover Plate

Nearby Sensor Target Sensor

Printed Circuit Board

© 2008 Microchip Technology Incorporated. All Rights Reserved. Capacitive m Touch Sensing Solutions Slide 33

As we saw earlier in this webseminar, covering plate thickness will also directly impact the Area variable in our capacitance equation.

**MICROCHIP**  
WebSeminars

## Thicker Covering Plates

$C = \frac{\epsilon_0 \epsilon_r A}{d}$  approaches  $C = \frac{\epsilon_0 \epsilon_r A}{d}$

Nearby Sensor Target Sensor

© 2008 Microchip Technology Incorporated. All Rights Reserved. Capacitive m Touch Sensing Solutions Slide 34

For example, as the covering plate thickness increases, notice that the difference in area of the nearby sensor actually approaches that of the target sensor in relation to the finger. Therefore, for optimal designs, the thinner the covering plate material, the better.

 **Dielectric Constant ( $\epsilon_r$ )**

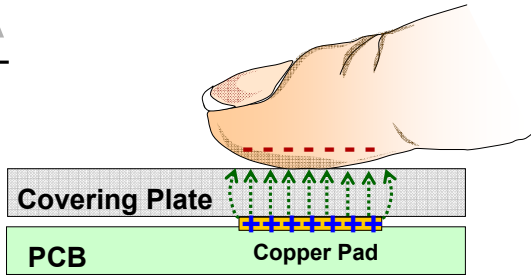
$$C = \frac{\epsilon_0 \epsilon_r A}{d}$$

$\epsilon_{r_{\text{glass}}} = 4 \rightarrow 8$

$\epsilon_{r_{\text{plexiglas}}} = 2.25 \rightarrow 3.5$

© 2008 Microchip Technology Incorporated. All Rights Reserved. Capacitive m Touch Sensing Solutions Slide 35

An important consideration when choosing a material for a covering plate is its permittivity or Dielectric Constant. This constant defines the amount of electrostatic energy or electric field that can be stored by a material when a given voltage is applied to it. As we can see in the capacitance equation, a higher dielectric constant produces a greater capacitance. Some dielectric constants for commonly used covering plate materials are Plexiglas defined at approximately 2.25 to 3.5 and glass between 4 to 8 depending on the type used. As you can probably guess considering the dielectric constants shown here, glass can maintain higher capacitances with greater thicknesses than could covering plates made of Plexiglas. Dielectric constants for materials are readily available.



# Other Considerations

© 2008 Microchip Technology Incorporated. All Rights Reserved. Capacitive m Touch Sensing Solutions Slide 36

Let's take a moment and look at some other considerations for a Capacitive mTouch Sensing design.

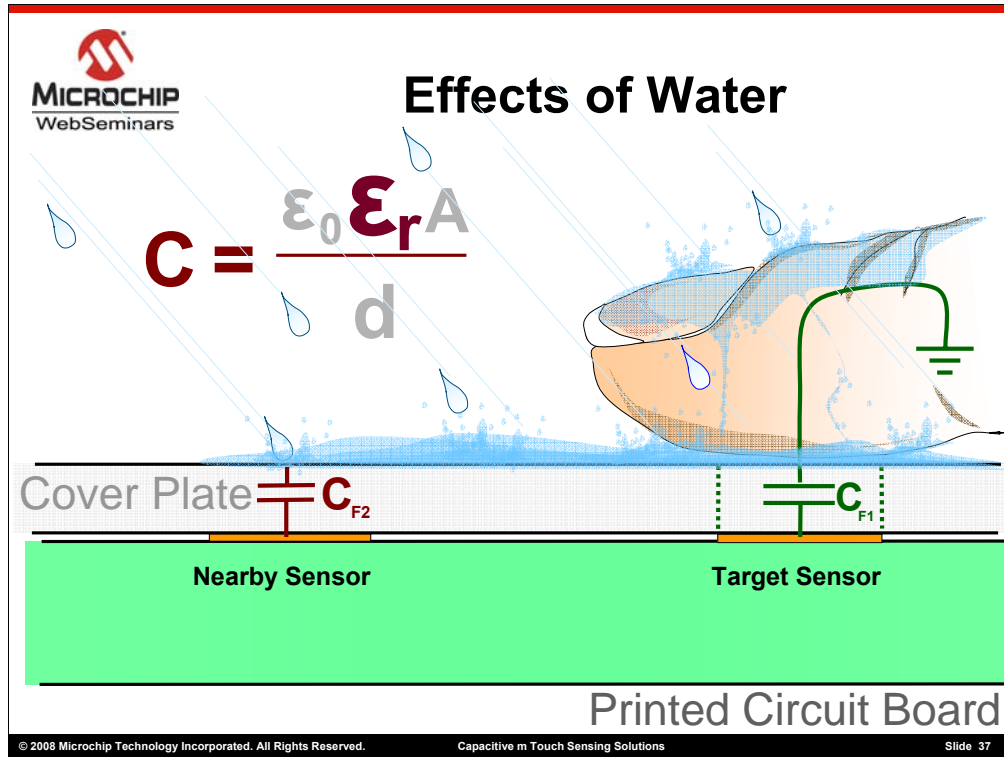

What about water on the touch surface of our application? Water has an extremely high permittivity of 70-75 in liquid form and around 2-3 if frozen. Therefore, water drop on a touch surface has the potential of being sensed as a sensor button press. Water covering a number of buttons could trigger multiple presses. Furthermore, touching a water puddle spanning multiple sensors could set them all off. Microchip suggests a percentage based voting routine described in the application note AN1103 "Software Handling for Capacitive Sensing" referenced at the end of this webseminar. By averaging in the relaxation oscillator frequency to the steady state environment, false triggers can be minimized. Ultimately, the best solution is to tilting the complete system in environments prone to water to allow drainage off of the touch surface. Certain covering materials may also be used that cause water to bead. However, dielectric constants for any additional materials must be carefully considered.

 **Condiments**

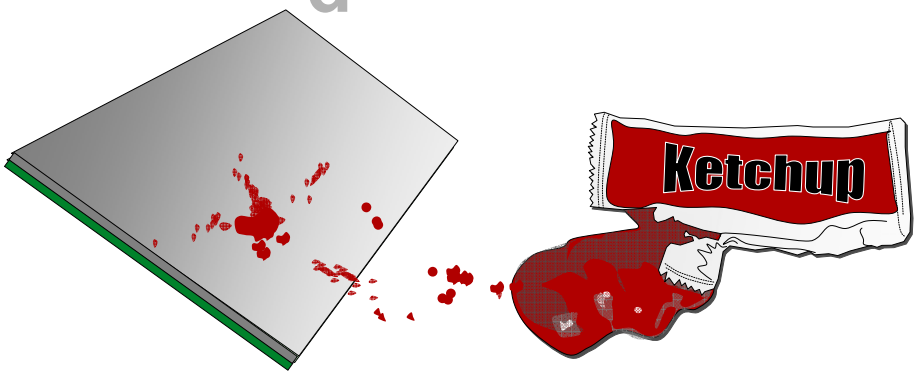
$$C = \frac{\epsilon_0 \epsilon_r A}{d}$$

© 2008 Microchip Technology Incorporated. All Rights Reserved. Capacitive m Touch Sensing Solutions Slide 38

Similarly, ketchup and mustard can cause false triggers due to their high moisture content. Especially in a splatter type environment a downward shift similar to a finger press can occur. The same averaging techniques described for overcoming false triggers due to water can be used. Alternately, you may consider using a press-and-release detection scheme. Here a specific window of time is used in which a press-and-release must occur. Anything too fast or too slow is not considered a press. One solution incorporates an algorithm in which an LED lights with the user's touch but a touch is not registered until the user releases the press.

 **Component Mounting**

- **Mount devices on one side of board opposite sensors**

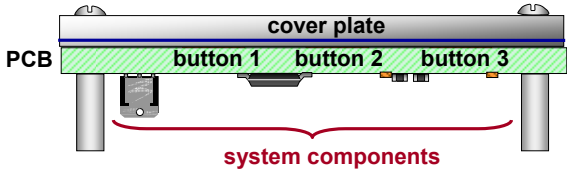

**Side View**

© 2008 Microchip Technology Incorporated. All Rights Reserved. Capacitive m Touch Sensing Solutions Slide 39

Another design practice to consider would be to mount devices such as the PIC MCU on the opposite side of the PCB to the sensors to create a flat/flush surface to accommodate covering plate and minimize air gaps. Again, avoid placing parts directly beneath the sensors. Centrally locating components may make routing traces easier and minimize disrupting sensor traces.



# Construction Sandwich

© 2008 Microchip Technology Incorporated. All Rights Reserved. Capacitive m Touch Sensing Solutions Slide 40

Let's take a moment and discuss how we would package all these components together into our final application.



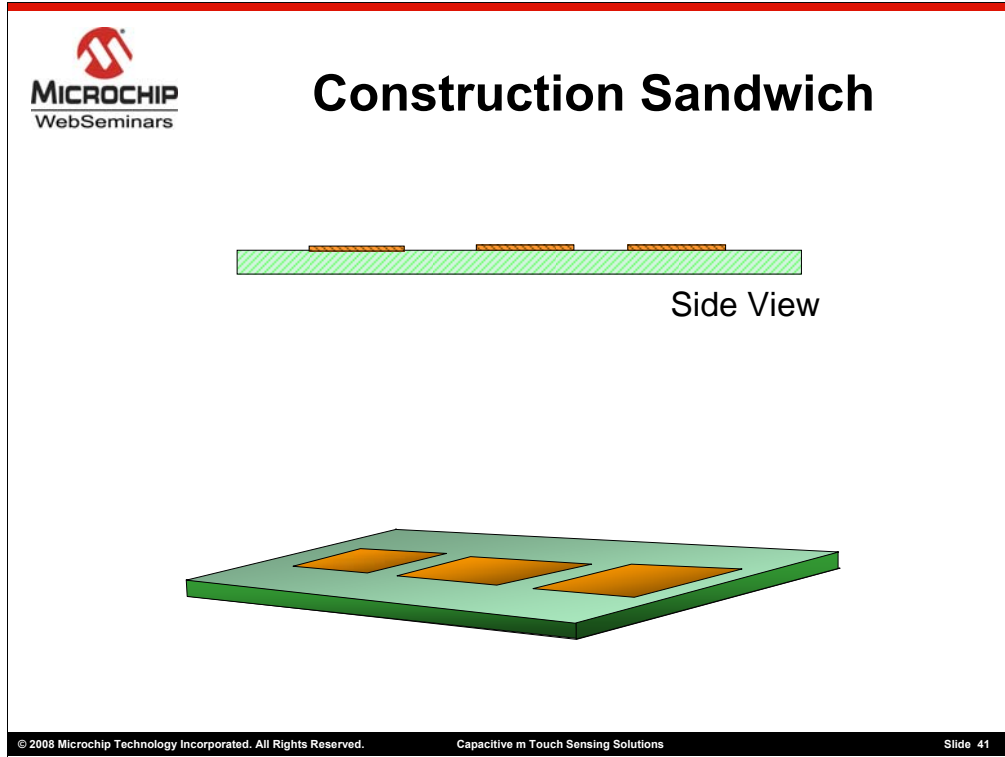

There are many ways to put together a completed system. This is simply one of them. You may choose an alternate method. This construction sandwich begins with the printed circuit board and sensors.

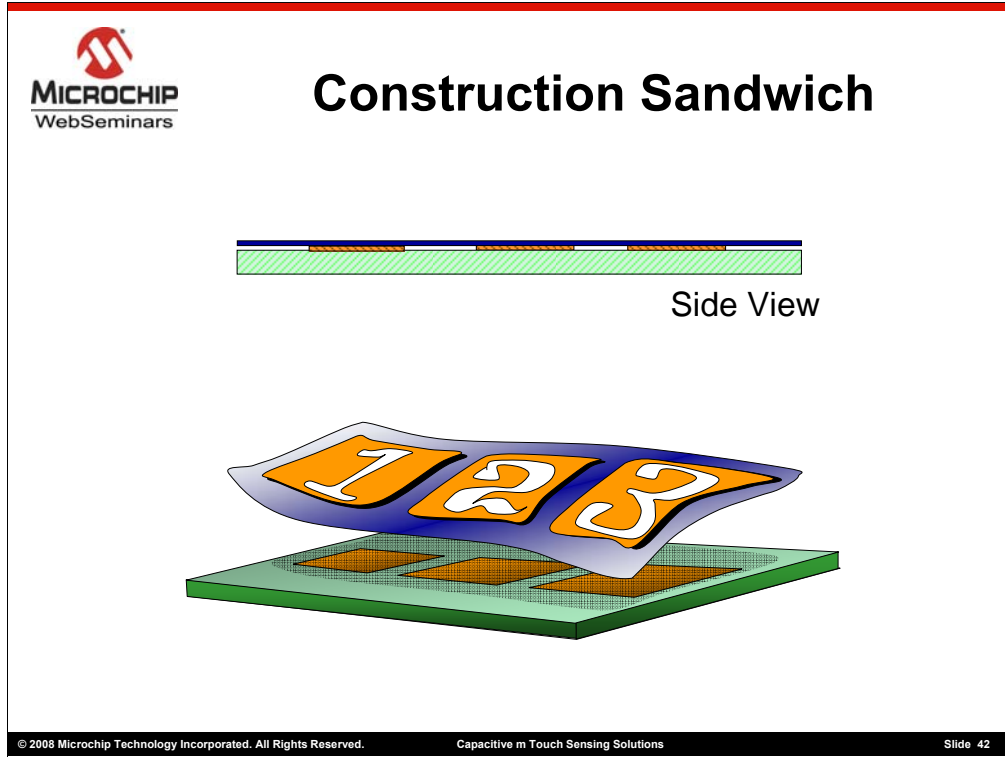

Next, a layer of paper is placed over the pads with graphics to indicate button locations. This is an inexpensive method that gives the designer freedom to produce an end product that aesthetically complements its environment. Alternately, you may consider silk-screening the bottom side of the cover plate.

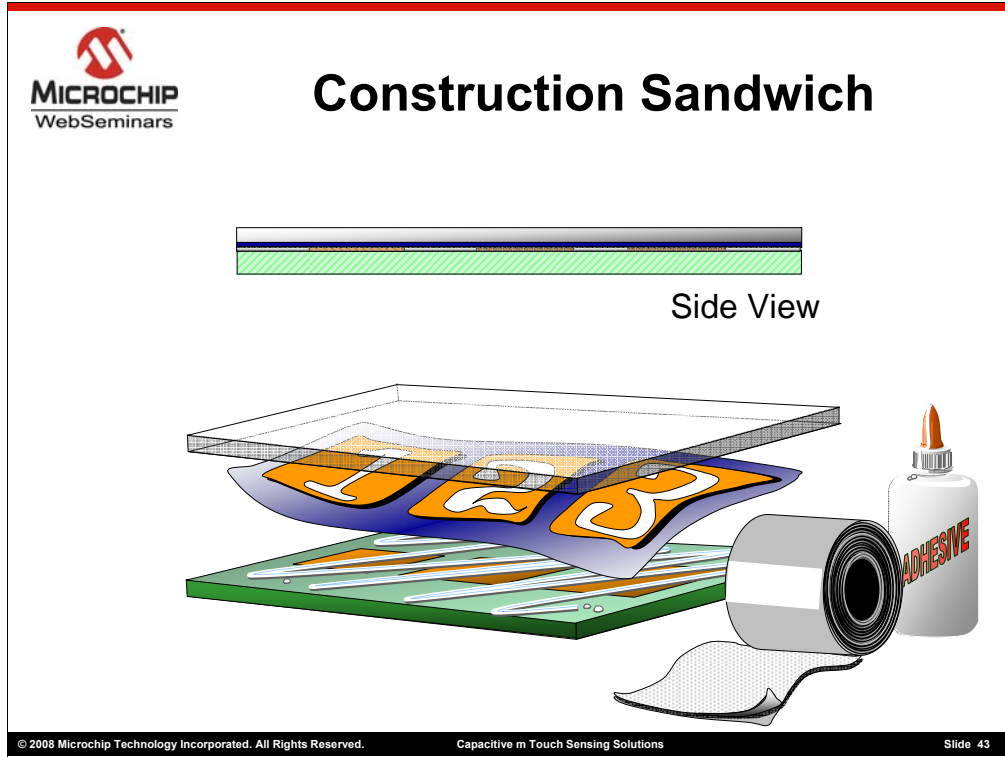

The construction sandwich is then secured using an adhesive such as glue or double-sided tape to give a clean look to the design. Using an adhesive of some sort will minimize air spaces between each layer which will optimize the capacitance of the system.



**MICROCHIP**  
WebSeminars

# Summary

© 2008 Microchip Technology Incorporated. All Rights Reserved. Capacitive m Touch Sensing Solutions Slide 44

Let's summarize what we have covered in this webseminar...

 **Agenda**

**Design Considerations:**

- Copper Pad Size
- Adjacent Touch Sensors
- Circuit Traces
- Covering Plate
- Other Considerations
- Mounting

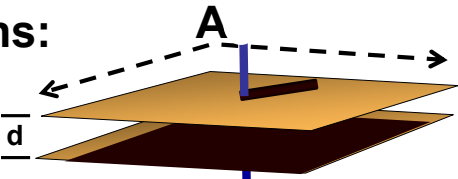
$$C = \frac{\epsilon_0 \epsilon_r A}{d}$$

© 2008 Microchip Technology Incorporated. All Rights Reserved. Capacitive m Touch Sensing Solutions Slide 45

During the course of this webseminar we have looked at a number of design guidelines to optimize your Capacitive mTouch™ Sensing application. Careful consideration must be taken especially during the layout stage of the printed circuit. Sensor size, placement and connectivity to other components will ultimately make or break the application. Covering plate materials and thicknesses must be chosen to optimize sensitivity of the system to a users touch while minimizing interference with other sensors. Some suggestions were offered in the final packaging of the design. The designer may find that other packaging methods better suit their application.



## For More Information

- **AN1101: Introduction to Capacitive Sensing**
- **AN1102: Layout and Physical Design Guidelines for Capacitive Sensing**
- **AN1103: Software Handling for Capacitive Sensing**
- **AN1104: Capacitive Multi-Button Configurations**
- **mTouch™ Design Center at [www.microchip.com/mTouch](http://www.microchip.com/mTouch)**

© 2008 Microchip Technology Incorporated. All Rights Reserved. Capacitive m Touch Sensing Solutions Slide 46

For more information on Microchip's Capacitive mTouch™ Sensing Solution, please refer to the application notes listed here. Future webseminar topics will include software algorithms, multi-button configurations and an overview of the mTouch Software Development Kit. You may also be interested in visiting the mTouch Design Center at [www.microchip.com/mTouch](http://www.microchip.com/mTouch). Here you will find links to the most current information and resources for this technology.



My name is Marc McComb and I thank you for viewing this webseminar.